



ENSURE THAT THESE INSTRUCTIONS ARE LEFT
FOR THE USER AFTER COMPLETION OF THE
BENCHMARK SECTION

ECOMFORT PLUS

User instructions



199838



Please read the Important Notice within
this guide regarding your boiler warranty



IMPORTANT NOTICE

For the first year all of our appliances are protected by our manufacturer's guarantee which covers both parts and labour.

As you would expect from Sime Ltd, it is our aim to provide our valued customers with the best in after sales and service.

To take advantage of any extended warranty offered, all you have to do is to adhere to these 3 simple conditions:

- The installation must be carried out to Manufacturers/Benchmark Standards by a Gas Safe Registered Engineer, and recorded in the installation manual.
- The appliance must be registered with both Sime Ltd and Gas Safe within 30 days of installation.
- The appliance must be serviced annually, by either Sime Ltd or a Gas Safe registered engineer- ensuring that the Benchmark service record in the installation manual is completed.

Failure to comply with the above will result in only the 12 month warranty being offered.

In the absence of any proof of purchase, the 12 month warranty period will commence from the date of manufacture of the boiler as shown on the appliance data plate.

Code Of Practice

For the installation, commissioning and servicing
of domestic heating and hot water products

Benchmark places responsibilities on both manufacturers and installers.* The purpose is to ensure that customers** are provided with the correct equipment for their needs, that it is installed, commissioned and serviced in accordance with the manufacturer's instructions by competent persons and that it meets the requirements of the appropriate Building Regulations. Installers are required to carry out work in accordance with the following:

Standards of Work

- Be competent and qualified to undertake the work required.
- Install, commission, service and use products in accordance with the manufacturer's instructions provided.
- Ensure that where there is responsibility for design work, the installation is correctly sized and fit for purpose.
- Meet the requirements of the appropriate Building Regulations. Where this involves notifiable work be a member of a Competent Persons Scheme or confirm that the customer has notified Local Authority Building Control (LABC), prior to work commencing.
- Complete all relevant sections of the Benchmark Checklist/Service Record when carrying out commissioning or servicing of a product or system.
- Ensure that the product or system is left in a safe condition and, whenever possible, in good working order.
- Highlight to the customer any remedial or improvement work identified during the course of commissioning or servicing work.
- Refer to the manufacturer's helpline where assistance is needed.
- Report product faults and concerns to the manufacturer in a timely manner.

Customer Service

- Show the customer any identity card that is relevant to the work being carried out prior to commencement or on request.
- Give a full and clear explanation/demonstration of the product or system and its operation to the customer.
- Hand over the manufacturer's instructions, including the Benchmark Checklist, to the customer on completion of an installation.
- Obtain the customer's signature, on the Benchmark Checklist, to confirm satisfactory demonstration and receipt of manufacturer's instructions.
- Advise the customer that regular product servicing is needed, in line with manufacturers' recommendations, to ensure that safety and efficiency is maintained.
- Respond promptly to calls from a customer following completion of work, providing advice and assistance by phone and, if necessary, visiting the customer.
- Rectify any installation problems at no cost to the customer during the installer's guarantee period.



*The use of the word "installer" is not limited to installation itself and covers those carrying out installation, commissioning and/or servicing of heating and hot water products, or the use of supporting products (such as water treatment or test equipment).

**Customer includes householders, landlords and tenants.

The Benchmark Scheme

Sime Ltd is a licensed member of the Benchmark Scheme which aims to improve the standards of installation and commissioning of domestic heating and hot water systems in the UK and to encourage regular servicing to optimise safety, efficiency and performance.

Benchmark is managed and promoted by the Heating and Hotwater Industry Council.
For more information visit www.centralheating.co.uk

Please ensure that the installer has fully completed the Benchmark Checklist in the use and maintenance section of the installation instructions supplied with the product and that you have signed it to say that you have received a full and clear explanation of its operation.

The installer is legally required to complete a commissioning checklist as a means of complying with the appropriate Building Regulations (England and Wales).

All installations must be notified to Local Area Building Control either directly or through a Competent Persons Scheme.

A Building Regulations Compliance Certificate will then be issued to the customer who should, on receipt, write the Notification Number on the Benchmark Checklist.

This product should be serviced regularly to optimise its safety, efficiency and performance.

The service engineer should complete the relevant Service Record on the Benchmark Checklist after each service.

The Benchmark Checklist may be required in the event of any warranty work and as supporting documentation relating to home improvements in the optional documents section of the Home Information Pack.

CONTENTS

OPERATING INSTRUCTIONS FOR THE USER

1.1	INTRODUCTION	6
1.2	APPLIANCE OPERATION	
1.3	OPERATING INSTRUCTIONS	
1.4	MINIMUM CLEARANCES	7
1.5	ROUTINE SERVICING	
1.6	GENERAL INFORMATION	
1.7	SAFETY	8
	MECHANICAL TIME CLOCK - Code 8092213	8
	DIGITAL TIME CLOCK - Code 8092214	9
	ANALOGIC RF TIME PROGRAMMER - Code 8092221	10
	DIGITAL RF TIME PROGRAMMER - Code 8092223	11

These appliances comply with the S.E.D.B.U.K. scheme, band "A"

VERY IMPORTANT!

**PLEASE MAKE SURE YOUR BENCHMARK CHECKLIST IN THE
INSTALLATION GUIDE, IS FILLED IN CORRECTLY.**

ALL GAS SAFE REGISTER INSTALLERS CARRY A ID CARD.

**THE REGISTRATION NUMBER SHOULD BE
RECORDED ON THE CHECK LIST.**

**YOU CAN CHECK YOUR INSTALLER IS GAS SAFE
REGISTERED BY CALLING ON 0800 408 5577**

OPERATING INSTRUCTIONS FOR THE USER

THE GAS SAFETY (INSTALLATION AND USE) REGULATIONS 1996. It is the law that all gas appliances are installed by a registered person, in accordance with the above regulations. Failure to install appliances correctly could lead to prosecution. It is in your own interest, and that of safety, to ensure that the law is complied with.

It is essential that the appliance is correctly earthed. An electricity supply of 240 V - 50 Hz fused at 3 A is required. Read these instructions carefully before attempting to operate the appliance.

1.1 INTRODUCTION

The Sime "ECOMFORT PLUS" is a fully automatic, wall mounted, room sealed, fan assisted combination boiler. When operating in winter mode, the appliance provides central heating as required and produces instantaneous hot water upon demand.

When operating in summer mode, the central heating is not operational however the appliance continues to supply hot water whenever it is required. The heat output is automatically controlled by the fully modulating gas valve (within its preset limits), and there are user adjustable potentiometers to control the temperature of both central heating and domestic hot water. A temperature/pressure gauge is fitted and an overheat thermostat is incorporated to protect against fault conditions.

1.2 APPLIANCE OPERATION

A demand of hot water will be sensed by the appliance detecting water flow (providing that the flow rate is above 2 l/m - 0.5 gal/min).

The fan will start and the burner will light at full output. If the draw off rate is near the maximum design flow rate the appliance will run continuously at full output until a tap

is either turned off or the flow rate is reduced in which case the heat output will reduce accordingly to maintain a steady temperature.

Hot water is made available almost immediately at the appliance outlet, but the final temperature and time taken for the hot water to reach a tap depends upon the potentiometer setting, the rate at which water is drawn off, and the length of the pipe between the boiler and the tap.

When the tap is turned off, the appliance will revert to C.H. mode (if set on winter position) otherwise the burner will be extinguished pending the next demand for hot water.

1.3 OPERATING INSTRUCTIONS

1.3.1 To light the appliance (see fig. 1)

- Check that the electricity supply is off and that the D.H.W. isolation valve is in the open position (lever vertical). Check that the gas supply is on.
- Turn the selector switch summer/winter (C) to SUMMER (water only) position "☼".
- Switch on the electricity supply and full open any D.H.W. tap. The burner will light.
If the burner fails to light, turn the selector switch summer/winter to "🔧" position and release it immediately; then turn it to the SUMMER position: the burner should now light. Turn off the tap.
- Check that the room thermostat and time clock are calling for heat. Turn the heating potentiometer (E) to maximum (fully clockwise).
- Turn the selector switch summer/winter to the WINTER position "❄️" and the burner will light to serve the heating load. Set the required temperature for the C.H. and D.H.W. by rotating the potentiometers (D - E) clockwise to increase or anticlockwise to decrease the temperature.

NOTE: when operating in winter mode, priority is auto-

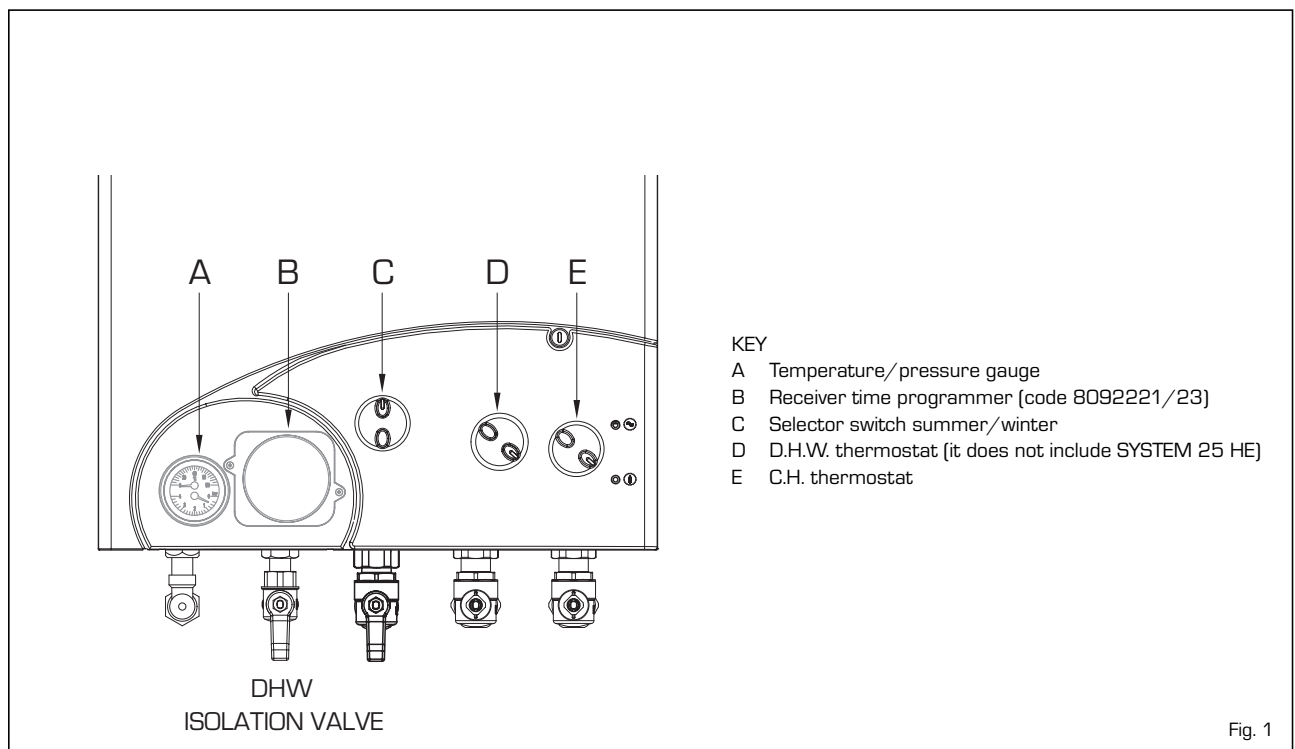

Fig. 1

matically given to providing hot water when the demand arises.

1.3.2 To turn off the appliance (see fig. 1)

- For short periods:

Set the selector switch (C) to the OFF position and urn off the DHW Isolation valve. When required, restore turn the selector switch to either the SUMMER or WINTER position and turn on the DHW Isolation valve.

- For longer periods:

Set the selector switch (C) to the OFF position, turn off the DHW Isolation valve, turn off the gas isolation cock. When required, manually rotate the pump, open the gas isolation cock, turn on the DHW Isolation valve and turn the selector switch to either the SUMMER or WINTER position.

NOTE: If frost protection is required-turn the selector switch to the summer position, do not isolate the gas supply, turn off the DHW Isolation valve.

1.4 MINIMUM CLEARANCES

The following MINIMUM CLEARANCES must be available for servicing the appliance:

	For ventilation	For servicing
ABOVE THE APPLIANCE CASING	400 mm	300 mm
AT THE R.H.S.	15 mm	15 mm
AT THE L.H.S.	15 mm	15 mm
BELOW THE APPLIANCE CASING	200 mm	200 mm
IN FRONT OF THE APPLIANCE	100 mm	500 mm

1.5 ROUTINE SERVICING

To ensure continued efficient operation of the appliance, it is recommended that it is checked and serviced as necessary at regular intervals. The frequency of servicing will depend upon the particular installation conditions and usage but in general once a year should be adequate. It is the law that any service work must be carried out by a Gas Safe Register registered engineer.

1.6 GENERAL INFORMATION

1.6.1 Fault finding indicators (LEDS)

The appliance is fitted with a safety cut-out thermostat. In the event of overheating this will interrupt the power supply and prevent the appliance from functioning. If this occurs, allow the appliance to cool, turn the selector switch summer/winter to "⬇" position, then turn it back to the previous position (see fig. 2). If the cut-out condition is repeated, turn off the electrical supply and consult your installer or service engineer.

1.6.2 Temperature/pressure gauge

The gauge (A fig. 1) on the facia panel indicates the approximate system pressure. The normal operating pressure is between 1 and 1.5 bar. The pressure is maintained with the use of an external filling loop, fitted at the time of installation. This is usually close to the boiler. To increase the pressure, firstly connect the flexible hose, then turn on the isolation valve until the pressure is between 1 and 1.5 bar. Turn off the valve and disconnect the hose. If the normal running pressure is seen to decrease over a short period of time there is

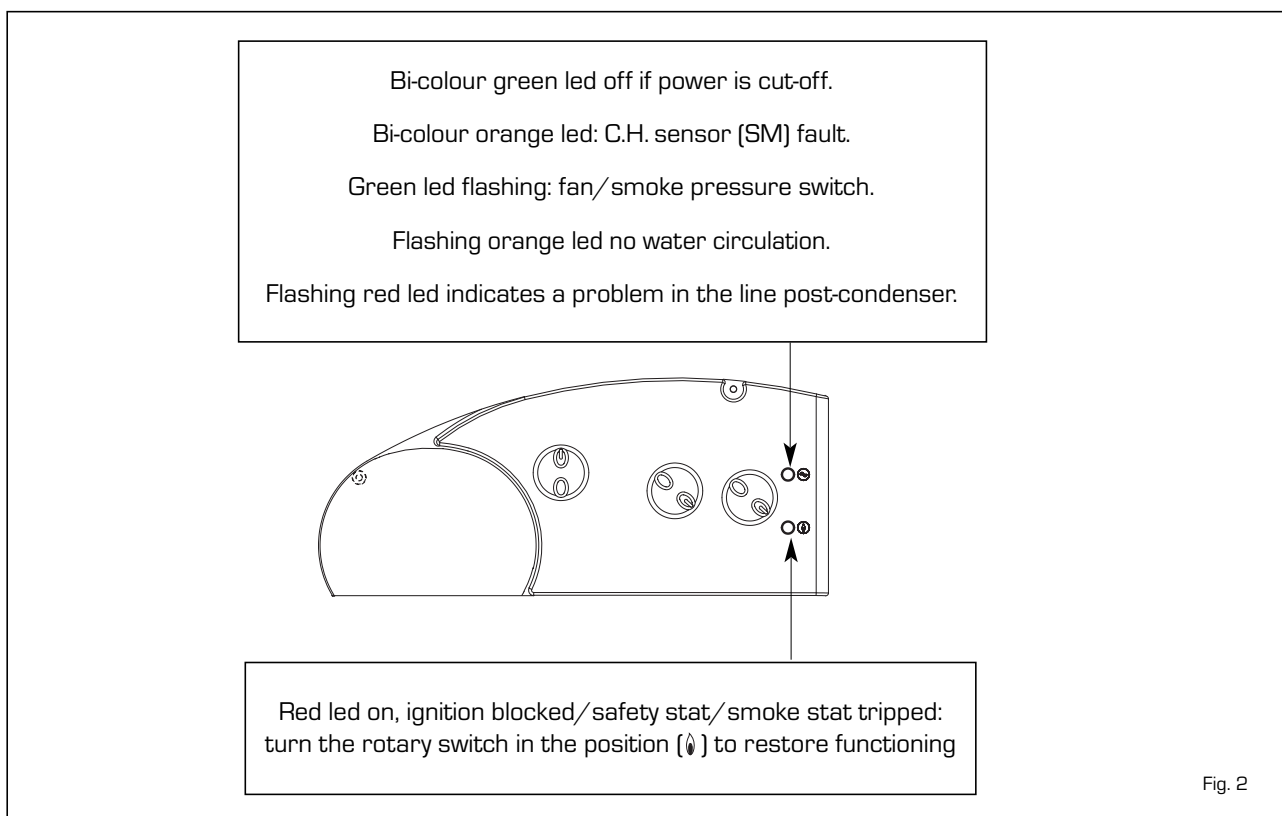



Fig. 2

a water leak and you should consult your installer or service engineer.

1.6.3 Electrical supply

The mains plug used must be a 3 pin type to BS1363, and fused at 3 A. THIS APPLIANCE MUST BE EARTHED.

NOTE: an interruption in the electricity supply whilst the burner is alight may cause the overheat thermostat to operate. If this is suspected, turn the rotary switch to “” position, then turn it back to the previous position.

TO CONNECT A PLUG

As the colour of wires in the mains lead of this appliance may not correspond with the coloured markings identifying the terminals in your plug, proceed as follows:

the wire which is coloured green and yellow must be connected to the terminal in the plug which is marked with the letter E or by the earth symbol - or coloured green and yellow; the wire which is coloured blue must be connected to the terminal marked with the letter N or coloured black; the wire which is coloured brown must be connected to the terminal marked with the letter L or coloured red.

1.6.4 Ventilation

If the appliance is installed in a cabinet, the latter MUST NOT be used for storage purposes.

Any ventilation provided for the appliance during installation MUST NOT be blocked and a periodic check must be made to ensure that the vents are free from obstructions.

1.6.5 Cleaning

Use only a damp cloth and mild detergent to clean the appliance outer casing. DO NOT use abrasive cleaners.

1.7 SAFETY

It is essential that the instructions in this booklet are strictly followed for the safe and economical operation of this appliance.

The appliance functions as a fan assisted balanced flue unit.

The flue terminal MUST NOT BE OBSTRUCTED under any circumstances. If damaged, turn off the appliance and consult the installer, service engineer, or gas supplier. If it is known or suspected that a fault exists on the appliance it MUST NOT be used until the fault has been rectified by a competent person.

WARNING: IF A GAS LEAK IS SUSPECTED OR EXISTS, TURN OFF THE GAS SUPPLY TO THE APPLIANCE AT THE GAS SERVICE COCK. DO NOT OPERATE ANY ELECTRICAL SWITCHES. DO NOT OPERATE ANY ELECTRICAL APPLIANCE. OPEN ALL WINDOWS AND DOORS. DO NOT SMOKE. EXTINGUISH ALL NAKED LIGHTS. CONTACT THE NATIONAL GAS EMERGENCY SERVICE IMMEDIATELY ON 0800111999.

MECHANICAL TIME CLOCK - Code 8092213

Setting the time

The time of day can be set by grasping the outer edge of the black dial and turning it in a clockwise direction until the correct time is in line with the white pointer.

Setting the “switching time”

The “ON” periods are set by sliding the blue tappets, adjacent to the time periods required, to the outer edge of the dial.

The tappets that remain at the centre of the dial will be the “OFF” periods.

N.B.: The smallest switching time (ON or OFF) is 15 minutes.

- To select “Timed” mode move the selector switch in the middle of the clock face to the “” position.
- To select “Constant” mode move the selector switch in the middle of the clock face to the “I” position.
- To select “OFF” mode move the selector switch in the middle of the clock face to the “O” position.

Slide blue tappets **IN** for **OFF** period

Mode selector switch

Slide blue tappets **OUT** for **ON** period

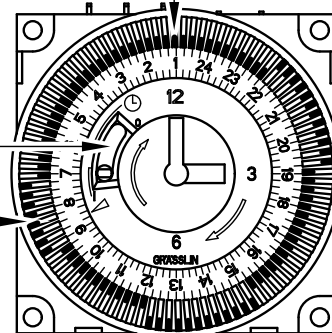

DIGITAL TIME CLOCK - Code 8092214

When the selector is in the "AUTO" position, boiler functioning is automatically controlled on the basis of the temperature levels and time periods set. The second selector must be in the "RUN" position to start. The programming procedure is described below:

- Setting the time

Set the selector to the "CLOCK" position. Press "h" to change the hour on the display, or "m" to change the minutes. To set the day, press the "1...7" button until the arrow is pointing to the correct day (1 = Monday... 7 = Sunday).



- Setting the program

The time clock has 8 on times and 8 off times. To make it easier to use, the time clock is supplied with 3 on times and 3 off times already set for each day of the week, as shown below:

Program	Time
1	06,00
2	09,00
3	12,00
4	14,00
5	18,00
6	22,00

NOTE: No program is set from 7 through 17.

To select programmes other than those already set, move the selector to position "P"; "0:001" will appear on the display, in which the first three digits indicate the hour and minutes, while the fourth digit identifies the program number. Odd-numbered programs identify requests for operation (day temperature), in which case the light bulb symbol will appear on the display, while even-numbered programs identify drops in temperature (night). Use the "1...7" key to select the day of the week (from 1 to 7) or days (1 ÷ 5, 6 - 7; 1 ÷ 6 or every day if the program is to be repeated every day of the week). Set the hour and minutes with the "h" and "m" buttons.

Press "P" to store the operation in memory and go on to the next program. Repeat the same procedure to set the remaining programs.

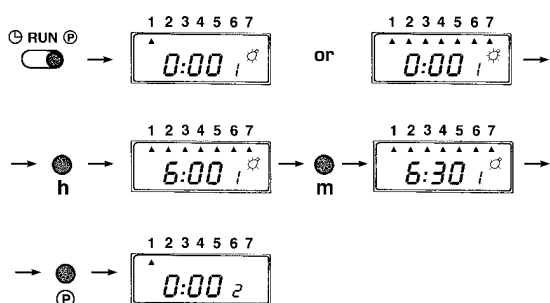

When finished programming, set the selector to "RUN" position.

- Deleting one or more programs

The on and off time must be deleted for each program to be deleted.

Set selector (2) to position "P". Select the desired program with button (3), then press button (4) to delete the day setting (the triangular symbols for the days should go away). If part of the program is deleted, when you set selector (2) back to the "RUN" position an error will appear in the clock display, referring to the program which is incorrect.

To delete all programs, put the selector in position "P" and press buttons (3) and (5) at the same time.

- Setting the SKIP function

The SKIP function deactivates programs for the next day and resumes regular programming 24 hours later.

This function is useful if you will be out all day and don't need heating.

To start this function, press button (7), which is active only when selector (2) is in "RUN" position.

Once you have selected the SKIP function, it will go into effect at 0:00 of the next day for 24 hours.

You cannot turn it off once it has started, so regular programming will not resume until 24 hours have passed.

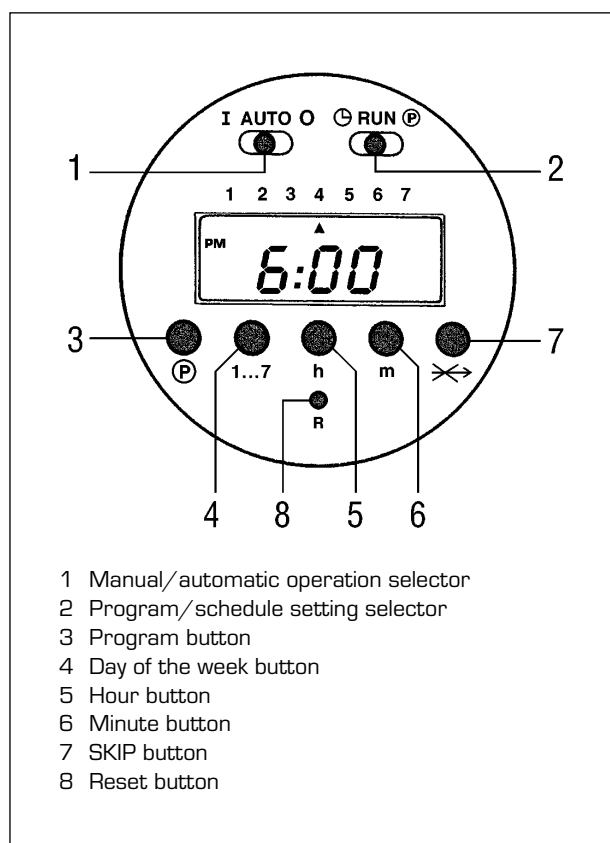

- 1 Manual/automatic operation selector
- 2 Program/schedule setting selector
- 3 Program button
- 4 Day of the week button
- 5 Hour button
- 6 Minute button
- 7 SKIP button
- 8 Reset button

ANALOGIC RF TIME PROGRAMMER - Code 8092221

4. Commissioning (The Receiver and the Transmitter are pre-commissioned)

- a. Turn on electrical supply to boiler and turn boiler selector to 
- b. Press and hold black button on Receiver until the neon light has flashed twice.
- c. Release the button and the neon light will remain illuminated.
- d. Insert the batteries into the Transmitter - the Transmitter will immediately send signals.
- e. When a signal is received from the Transmitter, the Receiver neon will go out. The radio link between the Transmitter and Receiver is now established.

Note: When in operation and an 'ON' signal is received the Receiver neon will illuminate continuously. When an 'OFF' signal is received the neon will remain off, but will flash intermittently. The boiler will operate in emergency mode, (heating on for 4 min, off for 9min) if the batteries are removed or discharged.

5. User Instructions - see Fig. 5

Note: Panel (A) slides back to reveal quick reference user instructions (B).

a. Set Time

Slide cover (D) off the Transmitter (C). Turn the outer dial clockwise to set the clock hands to the correct time. Ensure the time corresponds with the correct time on the 24hr dial as shown. e.g. 3.00pm = 15 not 3.

Note: Do not rotate anti-clockwise or damage may occur to the unit. Rotate the minute hand with your finger to set the exact time.

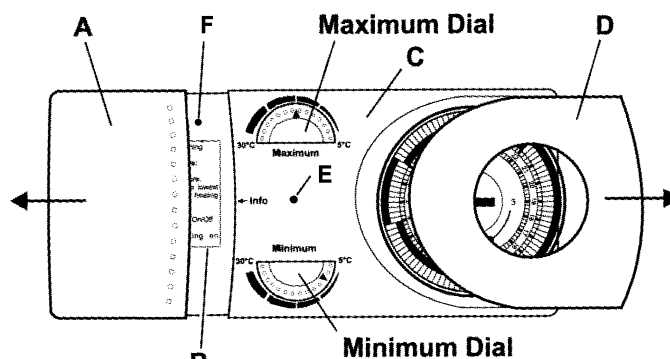

Fig. 5

b. Set Heating ON/OFF Periods

Select the ON times by pushing the tappets to the outside. Select the OFF times by pushing the tappets to the inside.

Fig. 6 shows the clock set as follows:

- ON 3.00pm to 10.00pm (15-22)
- OFF 10.00pm to 5.00am (22-5)
- ON 5.00am to 8.00am (5-8)
- OFF 8.00am to 3.00pm (8-15)

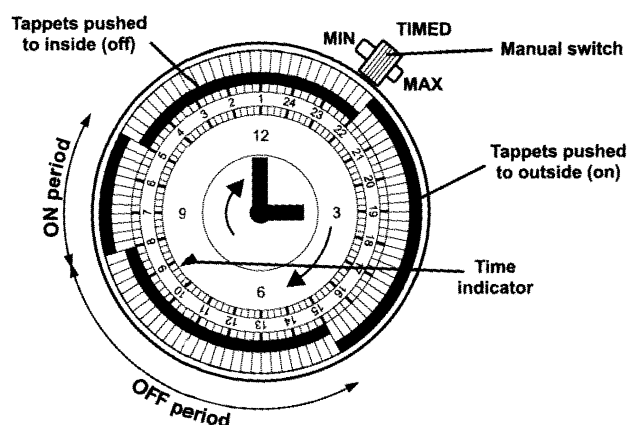

Fig. 6

c. Set Maximum/Minimum Room Temperatures

Maximum setting - Rotate the Maximum dial (see Fig. 5) to give the required room temperature upto 30°C when heating is on. Minimum setting - Rotate the Minimum dial (see Fig. 5) to a lower temperature down to 5°C to ensure that when the heating is off a minimum room temperature is maintained.





d. Manual Switch - see Fig. 6

The clock has a manual heating ON/OFF switch which operates as follows:

- TIMED position - Heating On/Off as set by tappets.
- MAX position - Heating On continuously.
- MIN position - Heating Off, but a minimum set room temperature is maintained.

DIGITAL RF TIME PROGRAMMER - Code 8092223











4. Commissioning (The Receiver and the Transmitter are pre-commissioned)

- Turn on electrical supply to boiler and turn boiler selector to 
- Press and hold black button on Receiver until the neon light has flashed twice.
- Release the button and the neon light will remain illuminated.
- Press and hold the top and bottom button on the Transmitter at the same time until Ed 01 is displayed. Then press 
- Then, Fu on (flashing) is displayed. Then press 
- The symbol  will flash on the Transmitter display approximately every 5 seconds. The transmitter is now in continuous radio operation.
- When a signal is received from the Transmitter, the Receiver neon will go out. The radio link between the Transmitter and Receiver is now established.
- Press the Selector button or  to return to normal operation.





Note: When in operation and an 'ON' signal is received the Receiver neon will illuminate continuously. When an 'OFF' signal is received the neon will flash intermittently. The boiler will operate in emergency mode, (heating on for 4 min, off for 9min) if the batteries are removed or discharged.

5. User Instructions - see Fig. 5





a. Set Time

- Press the Menu button until flashing  is displayed
- Press the /  buttons to set current HR, then press 
- Press the /  buttons to set current MIN, then press 
- Press the /  buttons to set current DAY (1 = Monday, 7 = Sunday), then press 

b. Set Maximum Room Temperature

- Press the Menu button until flashing  is displayed
- Press the /  buttons to select the required maximum room temperature, then press 



c. Set Minimum Room Temperature



- Press the Menu button until flashing  is displayed
- Press the /  buttons to select the required minimum room temperature, then press 

d. Set Heating Programme

- Press the Menu button until a flashing P1, P2, P3, P4 or Pd is displayed
- P1 - ON between 7am and 11pm
- P2 - ON between 6am and 9am then 5pm and 10pm
- P3 - ON for 24hrs
- P4 - OFF for 24hrs except when the minimum room temperature is reached, when it will come on
- Pd - Daily programmes can be set individually

Note: Programmes P1 to P4 cannot be changed.

If selecting a programme between P1 and P4 press the /  buttons until the programme required is displayed, then press  for each day.

To set a Pd programme, press the  button for **OFF** periods and press the  button for **ON** periods, then press . Repeat for each day.

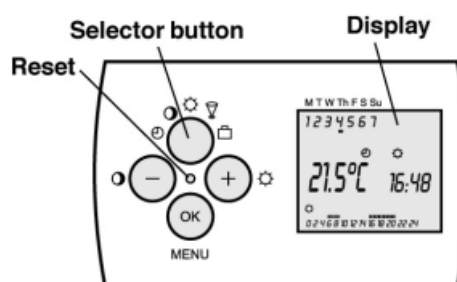

Fig. 5



Sime Ltd

1a Blue Ridge Park
Thunderhead Ridge
Glasshoughton, Castleford, WF10 4UA

Phone: 0845 9011114

Fax: 0845 9011115

www.sime.ltd.uk

Email: enquiries@sime.ltd.uk